

VM 18



Ultra resistant vacuum chamber



Electromechanical command panel



100% Made in Italy pump

Simplicity, comfort and reliability

"Manual planning in order to, once more, make the final user the only manager of any Vacuum process"

VM 18 incorporates all the features that distinguish Orved quality, such as the vacuum chamber, designed with particular attention to the hygienic aspect, found in the rounded corners that facilitate cleaning.

Equipped with H2out pump dehumidification cycle, VM 18 can pack any type of food and the Easy accessory allow the creation of external vacuum with surprising rapidity.

VM 18 is ideal for:



Small restaurant



Bar



Small gastronomy

Packing methods



Sealing only



Vacuum

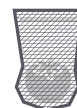

External vacuum

Technical data

- > Bodywork: stainless steel
- > Size: 582x576x496 mm
- > Chamber size: 448x440x188h mm
- > Weight: 72 kg
- > Power grid voltage: 240V 50/60Hz
- > Max power absorption: 1200 W
- > Sealing bars: 1x 420 mm
 - 2x 240 mm (on request)
 - 2x 345 + 1x 270 + 1x 310 mm (on request)
- > Vacuum pump: 25 mc/h
- > Max bag size: 400x500 mm
- > Wheelbase bars: 329 mm

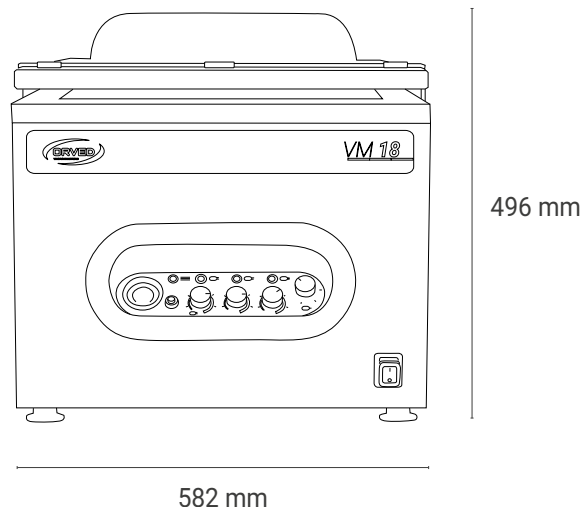

Standard equipment

 Easy accessory included

 H2out pump dehumidification program

Optional on request

 Nozzle for jars

 Softair

 Set of vacuum bags Premium

Matching accessories



Smooth vacuum bags



Channelled vacuum bags



Cooking vacuum bags



Carriage



Conserbox containers



Easy for external vacuum

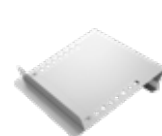

Inclined shelf for liquid products