

GELATO SHOWCASE



Fan cooling



Digital



LED lamp

* SGC-1200F



Tubs not included

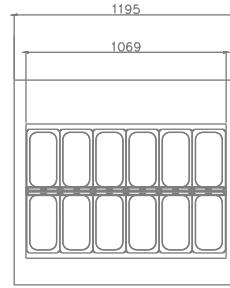

TOP

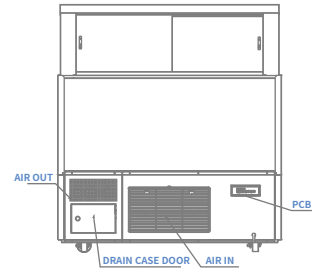

BACK

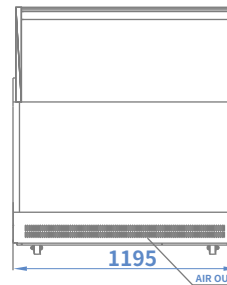

FRONT

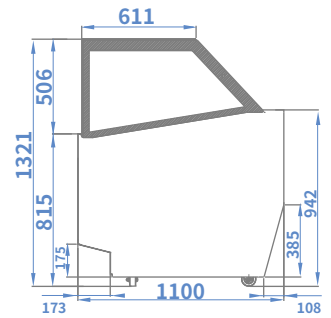

SIDE

* SGC-1500F



* SGC-1800F



* A lead time may apply to the models shown on this page.

MODEL	SGC-1200F	SGC-1500F	SGC-1800F
Classification	Freezer		
Cabinet Dimension (WxDxH mm)	1195 / 1547 / 1727 x 1034 x 1306		
Number of 1/3 Pans	12	16	18
Number of 1/2 Pans	8	10	12
Inner Temperature (°C)	-25 ~ -15		
Ambient Temperature(°C)	25(°C)		
Refrigerant	R-404a		
Insulation Type	Polyurethane / Cyclopentane + CFC Free		
Amps (A)	4.7	5.2	5.7
Voltage (V/Hz/Ph)	240 / 50 / 1		
Weight (Kg)	200	260	300
Door Type	Sliding Doors		
Power Plug	15A		
Power(W)	1034	1144	1254

GLASS DOOR MERCHANDISER

REACH-IN

UNDER COUNTER

BAR EQUIPMENT

ICE MAKER

DISPLAY CASE

SPECIAL MODEL

BAKING LINE