



SALAD & PIZZA TABLE

SALAD SIDE PREP TABLE [BUFFET]

SALAD SIDE PREP TABLE [HOOD]



SKIPIO

SALAD SIDE PREP TABLE BUFFET



Fan cooling



Digital



LED lamp

SSR9-1

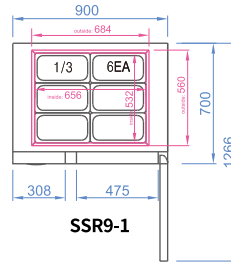

SSR9-1

SSR12-2

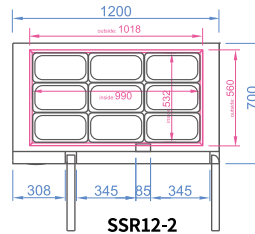

SSR12-2

SSR15-2

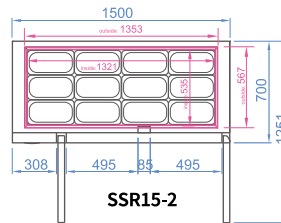

SSR15-2

SSR18-3

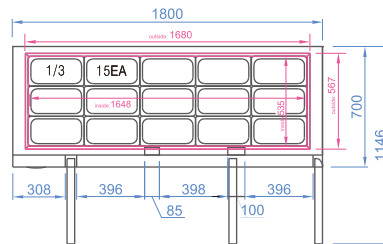

SSR18-3

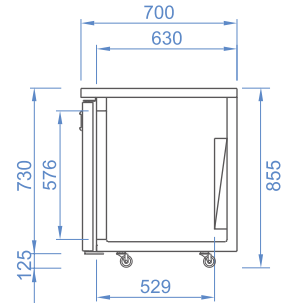

G/N Pan
(Pans Not Included)

MODEL	SSR9-1	SSR12-2	SSR15-2	SSR18-3
Classification	Refrigerator			
Cabinet Dimension (WxDxH mm)	900x 700 x 855	1200x 700 x 855	1500x 700 x 855	1800x 700 x 855
Capacity (ℓ)	233	343	458	568
Inner Temperature (°C)	-2~ 8			
Ambient Temperature (°C)	38			
Refrigerant	R-134a	R-134a	R-134a	R-134a
Insulation Type	Polyurethane / Cyclopentane + CFC Free			
Amps (A)	2.3	2.5	2.5	3
Voltage (V/Hz/Ph)	240 / 50 / 1			
Weight (Kg)	70	82	91	107
Power (W)	314	314	314	366
Number of Doors	1	2	2	3
Compressor (HP)	1/4	1/4	1/4	1/3
Number of Shelves	1	2	2	3
Power Plug	10A			

GLASS DOOR MERCHANDISER

REACH-IN

UNDER COUNTER

BAR EQUIPMENT

ICE MAKER

DISPLAY CASE

SPECIAL MODEL

BAKING LINE

SALAD SIDE PREP TABLE HOOD LID



Fan cooling Digital LED lamp

SHR9-1

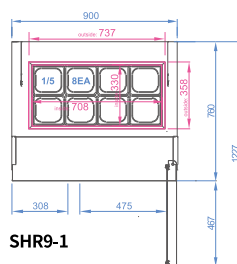

SHR9-1

SHR12-2

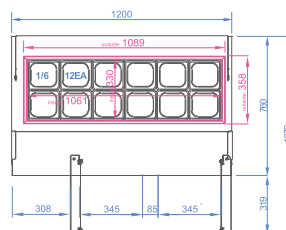

SHR12-2

SHR15-2

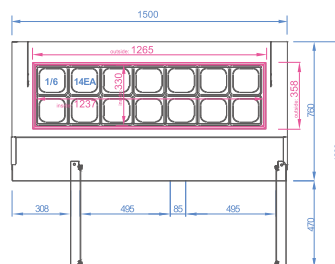

SHR15-2

SHR18-3

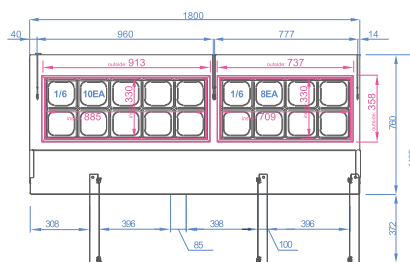

SHR18-3

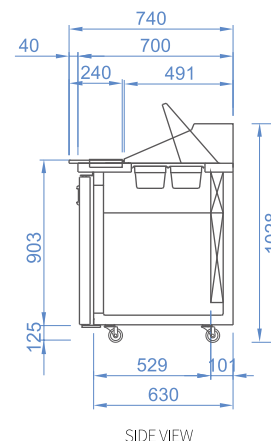

SIDE VIEW

G/N Pan

(1/6 Pans Included)

*Withstand temperature up to 70 °C

MODEL	SHR9-1	SHR12-2	SHR15-2	SHR18-3
Classification	Refrigerator			
Cabinet Dimension (WxDxH mm)	900x 700 x 1028	1200x 700 x 1028	1500x 700 x 1028	1800x 700 x 1028
Capacity (ℓ)	293	432	556	702
Inner Temperature (°C)	-2~ 8			
Ambient Temperature (°C)	38			
Refrigerant	R-134a	R-134a	R-134a	R-134a
Insulation Type	Polyurethane / Cyclopentane + CFC Free			
Amps (A)	2.3	2.5	2.5	3
Voltage (V/Hz/Ph)	240 / 50 / 1			
Weight (Kg)	75	89	100	120
Power (W)	314	314	314	366
Number of Doors	1	2	2	3
Compressor (HP)	1/4	1/4	1/4	1/3
Number of Shelves	1	2	2	3
Power Plug	10A			

PIZZA TABLE



Fan cooling



Digital



LED lamp

SPR-67SD



SPR-93SD

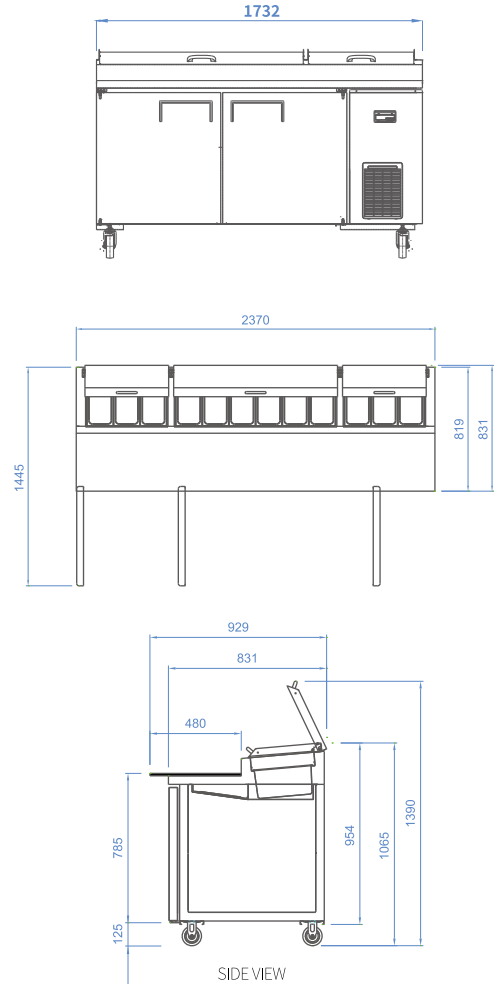

G/N Pan

(Pans Included)

*Withstand temperature up to 70 °C

MODEL	SPR-67SD	SPR-93SD
Classification	Refrigerator	
Cabinet Dimension (WxDxH mm)	1732x 929x 1065	2370x 929 x 1065
Capacity (ℓ)	450	872
Inner Temperature (°C)	1~ 8	
Ambient Temperature (°C)	38	
Refrigerant	R-134a	R-404a
Insulation Type	Polyurethane / Cyclopentane + CFC Free	
Amps (A)	2.7	3.8
Voltage (V/Hz/Ph)	240 / 50 / 1	
Weight (Kg)	105	262
Power (W)	370	660
Number of Doors	2	3
Number of Shelves	2	6
Number of Pans	9	12
Number of Hood	2	3
Compressor (HP)	1/3	1/2
Power Plug	10A	